

5MP ColorHunter With Smart Dual Light Turret Analog Camera

UAC-T145-AF28(40)LM-DL



Introduction

UAC-T145-AF28(40)LM-DL is a 5MP ColorHunter with smart dual light turret analog camera with a high-performance 1/2.7-inch CMOS sensor. It supports TVI/AHD/CVI/CVBS, which effectively enhances product adaptability and diversity of networking solutions. With SYV-75-3 or other coaxial cable types, the camera can achieve low-cost, long-distance, and anti-interference mega-pixel HD video transmission without time delay. The camera also supports audio input and synchronous transmission of audio and video. With UNV XVR, our ColorHunter cameras equipped with Smart Dual Light can intelligently switch between IR and white light when detecting a target or not, offering flexible lighting options and enhancing security.

Features

- High quality imaging with 5MP resolution
- TVI/AHD/CVI/CVBS
- Supports IR-cut filter with auto-switch (ICR)
- Smart Dual Light
- Supports 180° horizontal flip, 180° vertical flip
- OSD configuration menu, easy to operate
- IP67 waterproof and dustproof design, high reliability
- OSD configuration menu in 11 languages
- Built-in microphone for high quality audio transmission via coaxial cables

Specifications

Model	UAC-T145-AF28LM-DL	UAC-T145-AF40LM-DL
Sensor		
Pixel	5MP	
Size	1/2.7"	
Minimum illumination	0.005 lux (F1.6, AGC ON) 0 lux (Illuminator ON)	
Lens		
Lens	2.8mm	4.0mm
Lens mount	M12	
Angle of view	H: 110.0° V: 57.0° D: 130.0°	H: 90.0° V: 48.0° D: 109.1°
Illuminator		
Illuminator	Two IR illuminators; Two white-light illuminators	
Illumination distance	IR: 40m (131.23 ft) White light: 40m (131.23ft)	
Lifetime	≥60,000 hours	
Video		
Resolution	5MP@25fps: 2880(H)×1620(V); 5MP@20fps: 2592(H)×1944(V); 5MP@12.5fps: 2592(H)×1944(V) 4MP: 2560(H)×1440(V) 1080P: 1920(H)×1080(V)	
Frame rate	TVI: 5MP@20fps (default TVI), 5MP@12.5fps, 4MP@30fps, 4MP@25fps, 1080P@30fps, 1080P@25fps AHD: 5MP@20fps, 4MP@30fps, 4MP@25fps, 1080P@30fps, 1080P@25fps CVI: 5MP@25fps, 4MP@30fps, 4MP@25fps, 1080P@30fps, 1080P@25fps CVBS: PAL, NTSC	
Shutter time	PAL: 1/25s-1/50000s NTSC: 1/30s-1/50000s	
Image		
Exposure mode	Four modes: Global (default), BLC, HLC, DWDR	
Day/Night	Three modes: Auto (default), Day, Night	
Digital noise reduction	2D	
White balance	Two modes: Auto (default), Manual	
WDR	DWDR	
Light mode	Dual light (default), Infrared, White light	
Flip	Supports 180° horizontal flip, 180° vertical flip	
Audio		
Microphone	Built-in Mic	
Camera audio	TVI: 5MP@20fps, 5MP@12.5fps, 4MP@30fps, 4MP@25fps, 1080P@30fps, 1080P@25fps CVI: 5MP@25fps, 4MP@30fps, 4MP@25fps	
Interface		
Power	5.5mm power interface	
Video output	BNC, supports TVI/AHD/CVI/CVBS	
Operating environment		
Temperature	-30°C to 60°C (-22°F to 140°F)	
Humidity	≤95% (RH, non-condensing)	

Surge protection	4kV
General	
Power	DC 12V (±25%), with reverse polarity protection, Max 3.5W
Mount	Surface mount (default), optional backbox, wall mount bracket
Dimensions	Φ117.8mm*96.5mm (diameter*height)
Material	Metal+Plastic
Weight	239g (0.53lb)
OSD menu language	11 Languages English, German, Spanish(Latin America), French, Italian, Japanese, Korean, Polish, Portuguese(Brazil), Russian, Turkish
Certification	
EMC	CE-EMC (EN 55032,EN 61000-3-3,EN IEC 61000-3-2,EN 55035) FCC (FCC 47 CFR part15 B)
Safety	CE-LVD (EN 62368-1)
Environment	CE-RoHS (2011/65/EU;(EU)2015/863); WEEE (2012/19/EU)
Protection	IP67 (IEC 60529)

Dimensions

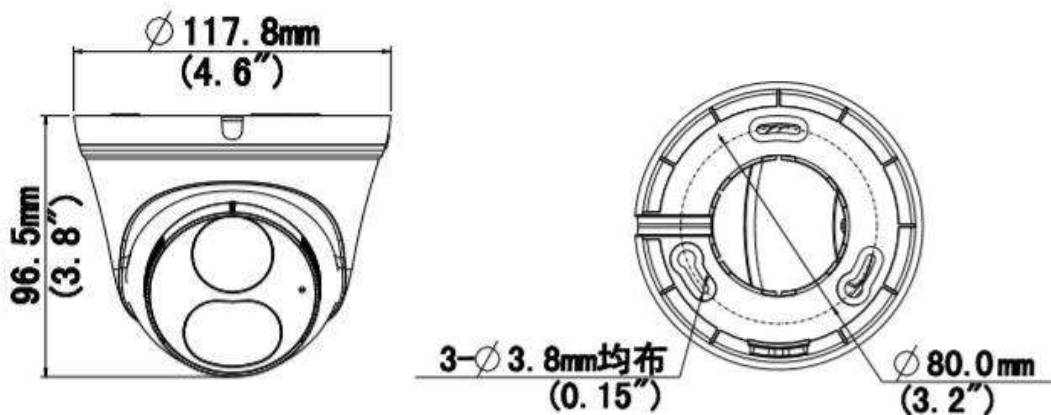

UAC-T145-AF28(40)LM-DL

Accessories

TR-JB03-I-IN

Junction Box



TR-JB07/WM03-G-IN

Wall Mount



TR-WM03-D-IN

Wall Mount



TR-WM07P-B

Wall Mount



TR-A01-IN

Waterproof Joint



TR-UP06-IN

Pole Mount



TR-UC08-C

Corner Mount

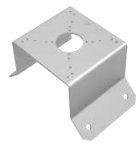

TR-SE24-A-IN

Pendant Mount



TR-CM24-IN

Pendant Mount



TR-SE24-IN

Pendant Mount



PWR-DC1201A-UK,
PWR-DC1201B-UK

Wall Plug-in UK
Power Adapter



PWR-DC1201A-US,
PWR-DC1201B-US

Wall Plug-in US
Power Adapter



PWR-DC1201A-EU,
PWR-DC1201B-EU

Wall Plug-in EU
Power Adapter



PWR-DC1201A-IND

Wall Plug-in IND
Power Adapter



Mount

TR-JB07/WM03-G-IN(TR-WM03-D-IN)+TR-UP06-IN

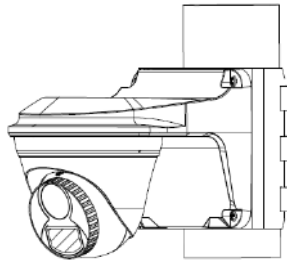

TR-JB03-I-IN

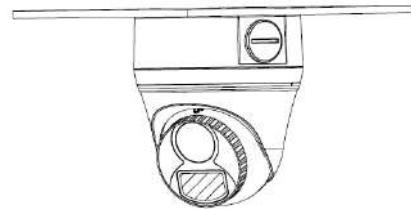

TR-JB07/WM03-G-IN(TR-WM03-D-IN)+TR-UC08-C

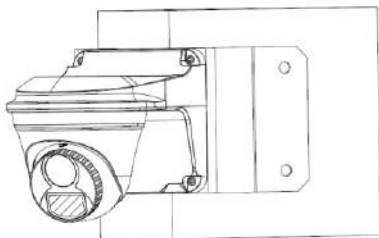

TR-CM24-IN+TR-JB03-I-IN

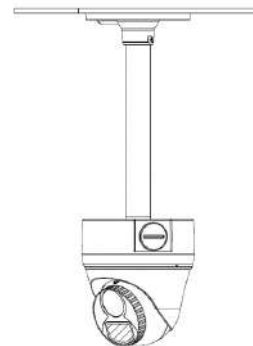

TR-WM07P-B

TR-JB07/WM03-G-IN(TR-WM03-D-IN)

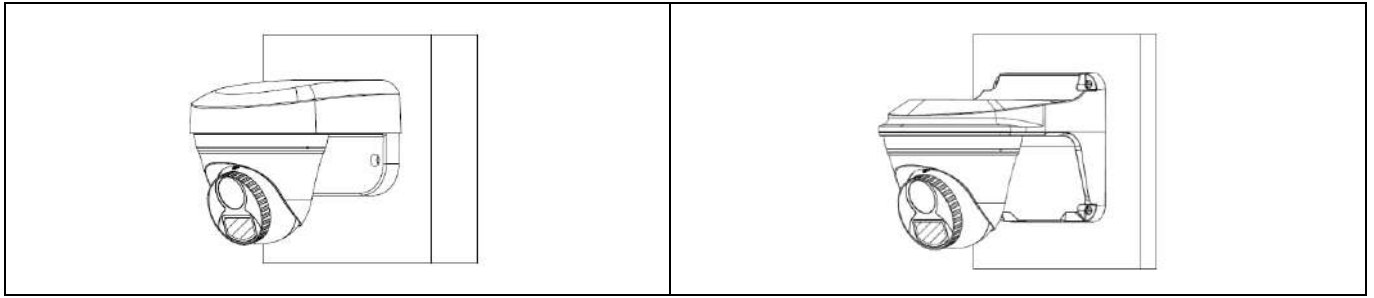

Zhejiang Uniview Technologies Co., Ltd.

Building No. 369, Xietong Road, Xixing Sub-district, Binjiang District, Hangzhou City, Zhejiang Province, China (310051)

Email: overseasbusiness@uniview.com; globalsupport@uniview.com

<https://www.uniview.com>

©2023 Zhejiang Uniview Technologies Co., Ltd. All rights reserved.

*Product specifications and availability are subject to change without notice.